









SEIPO®

Rev. 00
Data Date
27/09/2021

Emissione Issuance
Approvazione Approval

Schema di montaggio

Assembly diagram

<p>Componenti Components</p>		<p>Schienale alto x1 (A) High backrest x1 (A)</p>		<p>Schienale medio x1 (A) Medium backrest x1 (A)</p>		<p>Sedile x1 (B) Seat x1 (B)</p>		
<p>SERIE MESH MESH SERIES</p>		<p>Colonna a gas x1 (D) Gas lift x1 (D)</p>		<p>Base a 5 razze x1 (E) 5 star base x1 (E)</p>		<p>Ruota D.65 x5 (F) Castors Diam. 65mm x5 (F)</p>		<p>Movimento (G) Movement (G)</p>



MH02 - MH03 - MH04



MH05 - MH06 - MH07



MH08 - MH09 - MH10

1) Estrarre tutti i componenti dalla scatola

1) Extract all components from the box



2) Inserire le ruote (F) nella base (E) fino a quando non si sente un click al fine di bloccarle.

2) Insert the castors (F) in the base (E) until you hear a click for locking

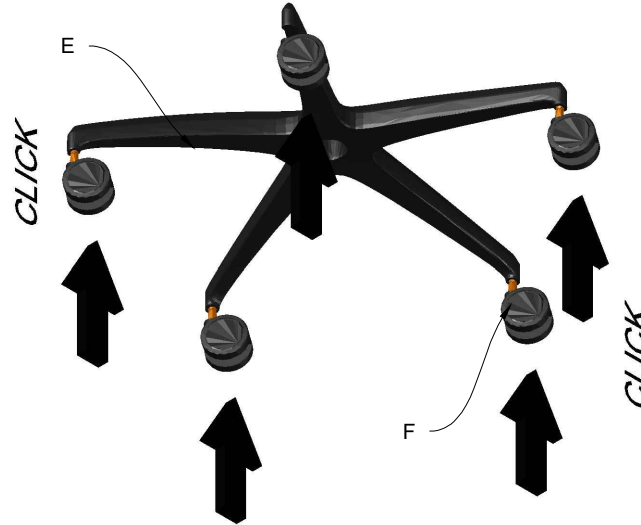

3) Inserire la colonna a gas (D) nel cono della base (E).

3) Insert the gas lift (D) in the cone of the base (E)

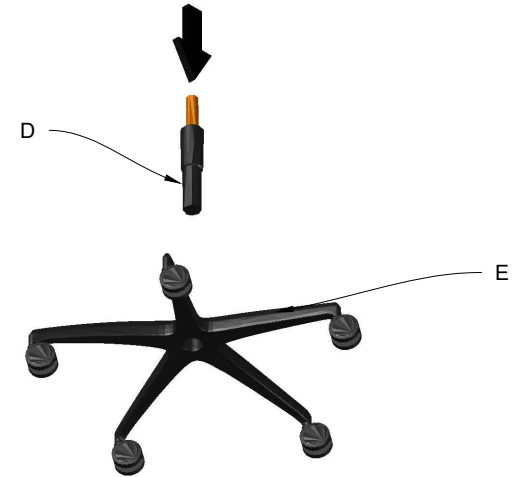

4) Colonna a gas (D) inserita nella base (E)

4) Gas lift (D) inserted in the base (E)

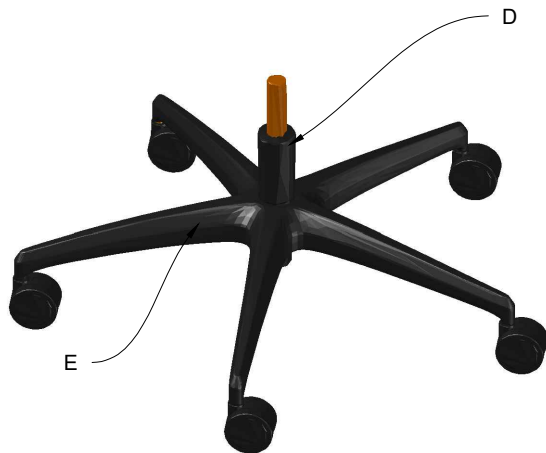

5) Fissare il movimento (G) al sedile (B) tramite i bulloni.

5) Fasten the movement (G) to the seat (B) by means of the bolts

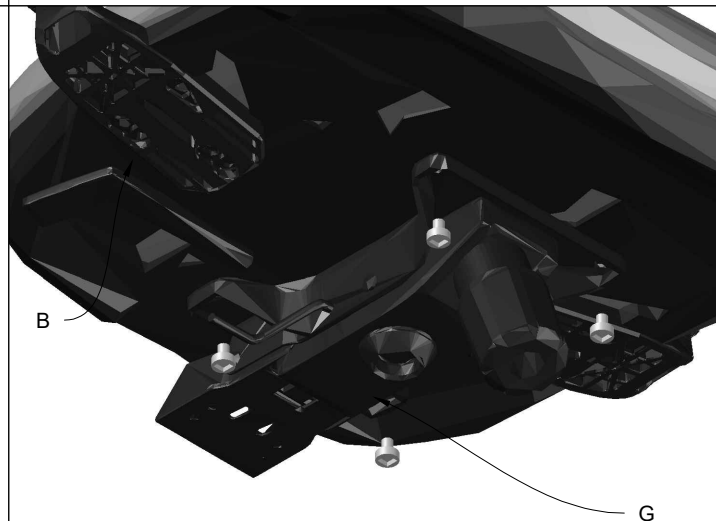

6) Inserire lo schienale (A) nel movimento (G) tramite i bulloni.

6) Insert the backrest (A) in the movement (G) by means of the bolts

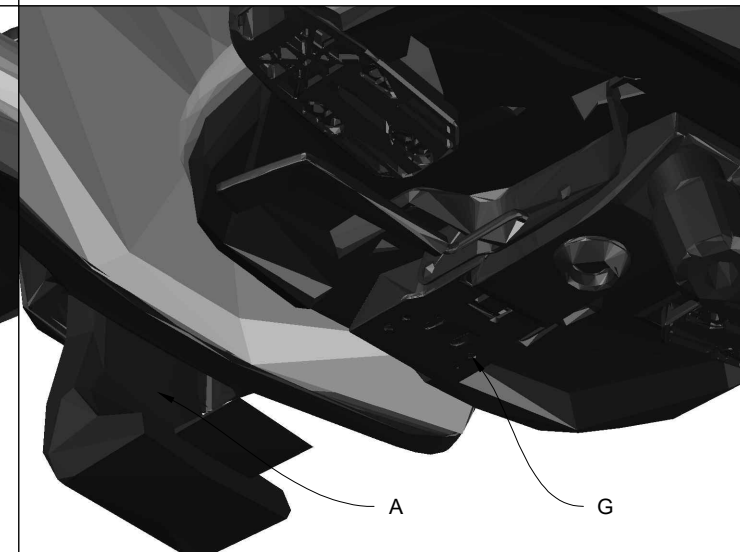

7) Posizionare il cono del movimento (G) nella colonna a gas (D) in modo da unire la scocca e le parti assemblate precedentemente.

7) Position the cone of the movement (G) on the gas lift (D) to unite the body to the beforehand assembled parts

