









# Schema di montaggio

# Assembly diagram

<b>Componenti</b> <b>Components</b>		Schienale medio x1 (A) Medium backrest x1 (A)		Schienale medio x1 (A) Medium backrest x1 (A)		Sedile x1 (B) Seat x1 (B)		Sedile x1 (B) Seat x1 (B)
<b>SERIE MASK-MESH</b> <b>MASK-MESH SERIES</b>		Colonna a gas x1 (C) Gas lift x1 (C)		Base 5 razze x1 (D) 5 star base x1 (D)		Ruota D.50 mm x5 (E) Castors Diam. 50 mm x5 (E)		Movimento (F) Movement (F)



MK01-MK02-MK03  
MK11-MK12-MK13



MK04-MK05-MK06  
MK14-MK15-MK16



MK07-MK08-MK09  
MK17-MK18-MK19

1) Estrarre tutti i componenti dalla scatola  
1) Extract all components from the box

2) Estrarre tutti i componenti dalla scatola  
2) Extract all components from the box

3) Inserire le ruote (E) negli appositi fori alle estremità delle razze situati nella base (D) fino a quando non si sente un click al fine di bloccarle.  
3) Insert the castors (E) in the base (D) until you hear a click for locking

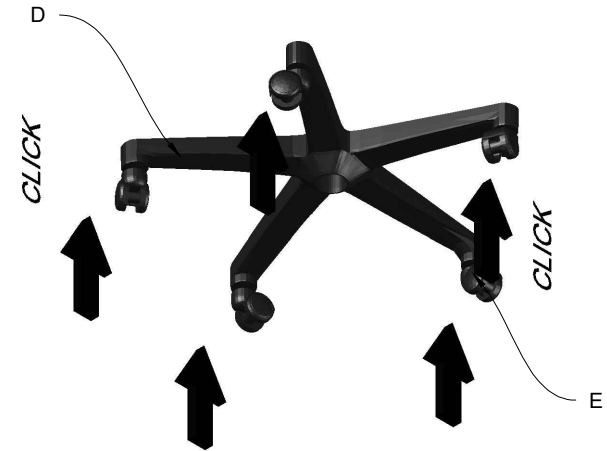

4) Inserire la colonna a gas (C) nel cono della base (D).  
4) Insert the gas lift (C) in the cone of the base (D)

5) Fissare il movimento (F) al sedile (B) tramite i bulloni.  
5) Fasten the movement (F) to the seat (B) by means of the bolts

6) Inserire lo schienale (A) e il movimento (F) nella piastra del sedile (B).  
6) Insert the backrest (A) and movement (F) in the seat plate (B)

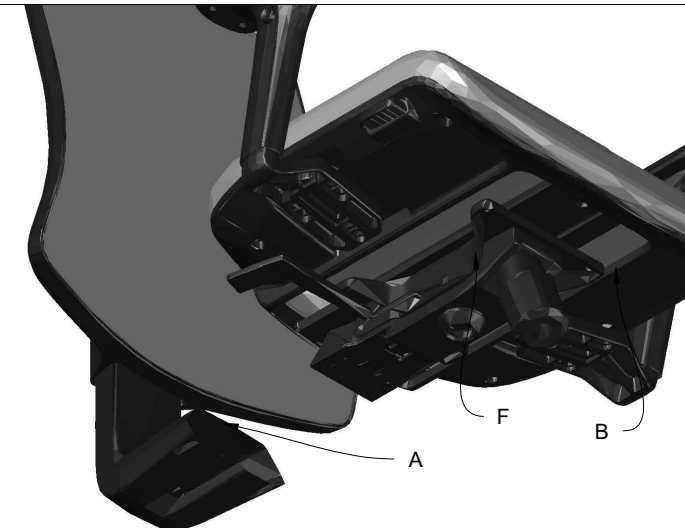
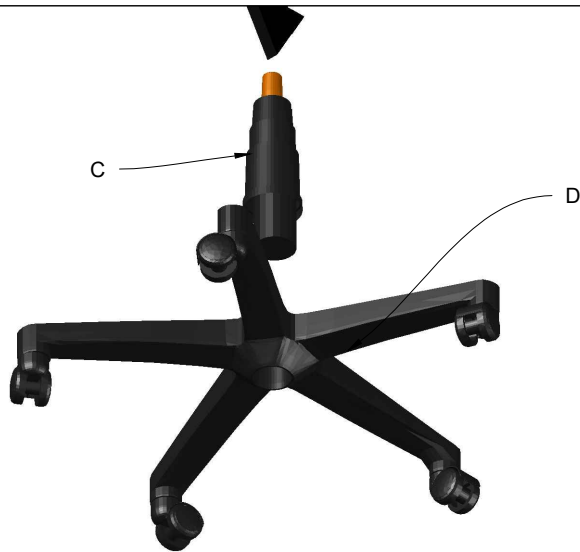

7) Posizionare il cono della piastra del sedile (B) nella colonna a gas (C) in modo da unire la scocca e le parti assemblate precedentemente.  
7) Position the cone of the seat plate (B) on the gas lift (C) to unite the body and the beforehand assembled parts

