







Schema di montaggio

Assembly diagram

| | | | | | | | | |
|-------------------------------------|---|--|--|--|---|--|---|---------------------------------------|
| <p>Componenti Components</p> |  | <p>Schienale medio x1 (A) Medium backrest x1 (A)</p> |  | <p>Schienale medio x1 (A) Medium backrest x1 (A)</p> |  | <p>Sedile x1 (B) Seat x1 (B)</p> | | |
| <p>SERIE Q-TRE Q-TRE SERIES</p> |  | <p>Colonna a gas x1 (C) Gas lift x1 (C)</p> |  | <p>Base 5 razze x1 (D) 5 star base x1 (D)</p> |  | <p>Ruota D.50 mm x5 (E) Castors Diam. 50 mm x5 (E)</p> |  | <p>Movimento (F) Movement (F)</p> |



Q021-Q022-Q023
Q024-Q025-Q026
Q027-Q028-Q029



Q030-Q031-Q032
Q033-Q034-Q035



Q041-Q042-Q043
Q044-Q045-Q046
Q047-Q048-Q049

- 1) Estrarre tutti i componenti dalla scatola
1) Extract all components from the box



- 2) Estrarre tutti i componenti dalla scatola
2) Extract all components from the box



- 3) Inserire le ruote (E) negli appositi fori alle estremità delle razze situati nella base (D) fino a quando non si sente un click al fine di bloccarle.
3) Insert the castors (E) in the base (D) until you hear a click for locking

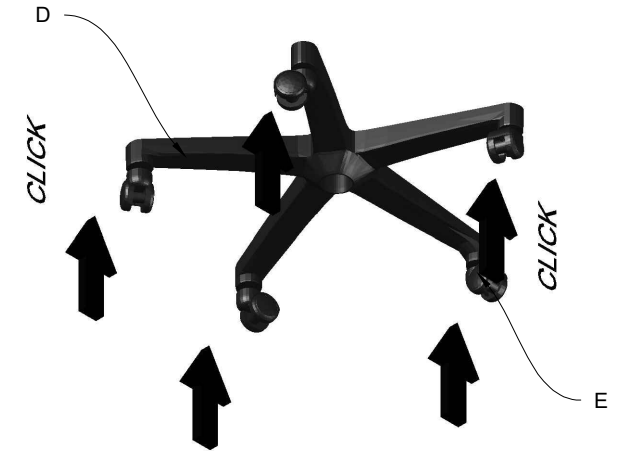

- 4) Inserire la colonna a gas (C) nel cono della base (D).
4) Insert the gas lift (C) in the cone of the base (D)

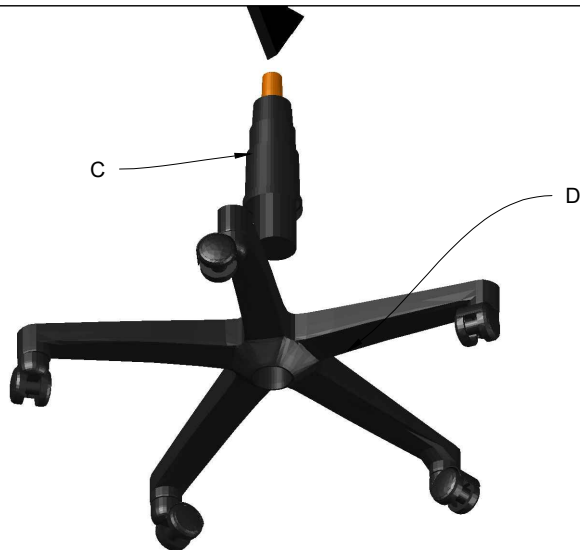

- 5) Fissare il movimento (F) al sedile (B) tramite i bulloni.
5) Fasten the movement (F) to the seat (B) by means of the bolts

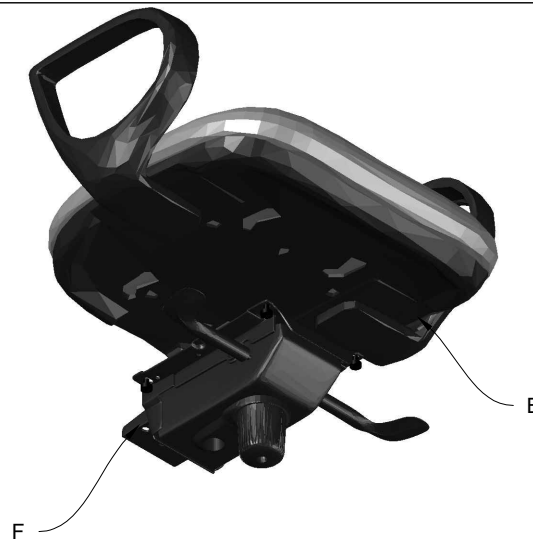

- 6) Inserire lo schienale (A) e il movimento (F) nella piastra del sedile (B).
6) Insert the backrest (A) and movement (F) in the seat plate (B)

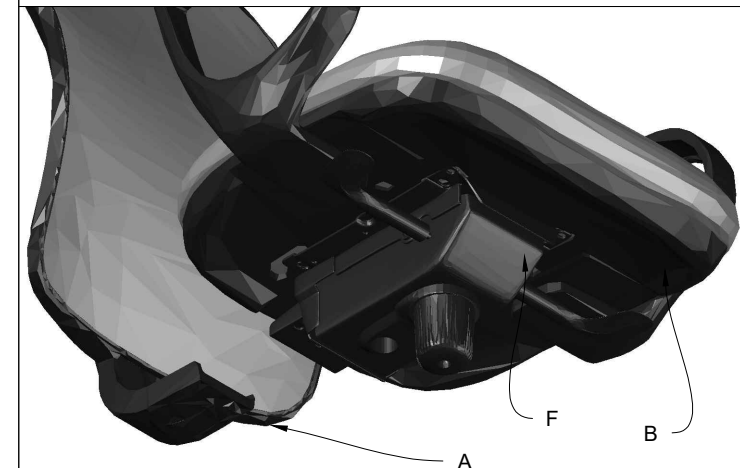

7) Posizionare il cono della piastra del sedile (B) nella colonna a gas (C) in modo da unire la scocca e le parti assemblate precedentemente.
7) Position the cone of the seat plate (B) on the gas lift (C) to unite the body and the beforehand assembled parts

