







<p>Componenti Components</p>		<p>Scocca alta x1 (A) High backrest x1 (A)</p>		<p>Scocca bassa x1 (A) Low backrest x1 (A)</p>		<p>Scocca bassa x1 (A) Low backrest x1 (A)</p>		
<p>SERIE ROMBO ROMBO SERIES</p>		<p>Colonna a gas x1 (B) Gas lift x1 (B)</p>		<p>Base a 5 razze x1 (C) 5 star base x1 (C)</p>		<p>Ruota D.65 x5 (D) Castors Diam. 65mm x5 (D)</p>		<p>Movimento (E) Movement (E)</p>

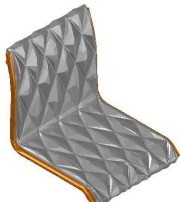

R001 - R002 -R004
R016 - R017 -R019



R005 - R006 -R008
R020 - R021 -R023



R010 - R011
R025 - R026

- 1) Estrarre la scocca (A) dalla scatola
1) Extract the body (A) and movement from the box



- 2) Estrarre la base (C) la colonna a gas (B) e le ruote (D) dalla scatola
2) Extract the base (C), gas lift (B) and castors (D) from the box

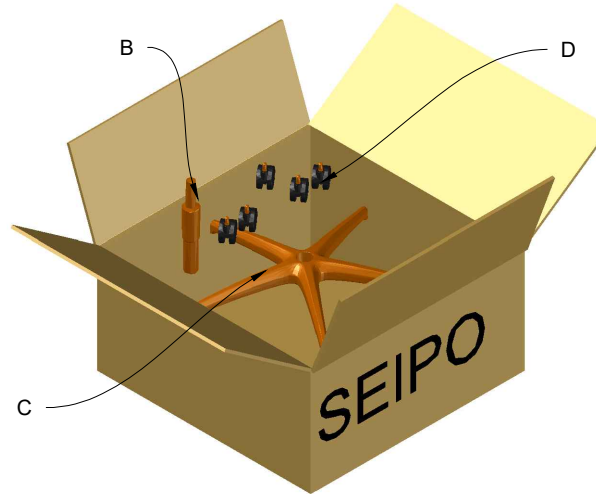

- 3) Inserire le ruote (D) nella base (C) fino a quando non si sente un click al fine di bloccarle.
3) Insert the castors (D) in the base (C) until you hear a click for locking

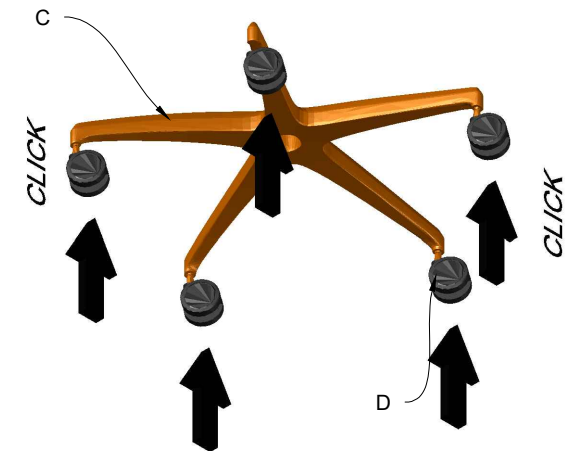

- 4) Inserire la colonna a gas (B) nel cono della base (C).
4) Insert the gas lift (B) in the cone of the base (C)

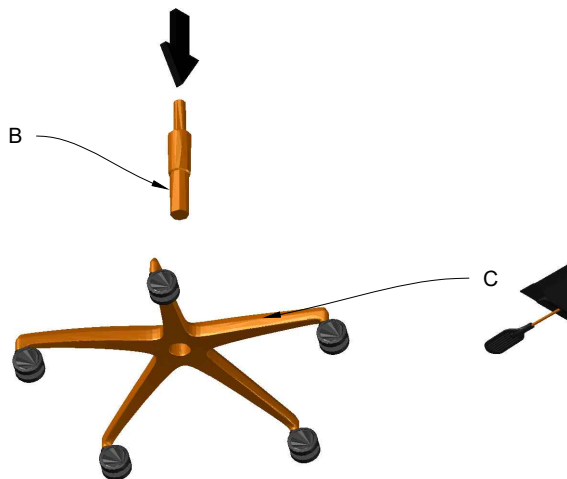

- 5) Colonna a gas (B) inserita nella base (C)
5) Gas lift (B) inserted in the base (C)

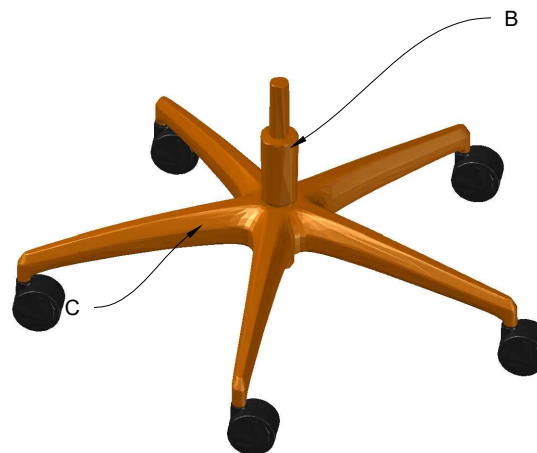

- 6) Fissare il movimento (E) alla scocca (A) tramite i bulloni.
6) Fasten the movement (E) to the seat (A) by means of the bolts

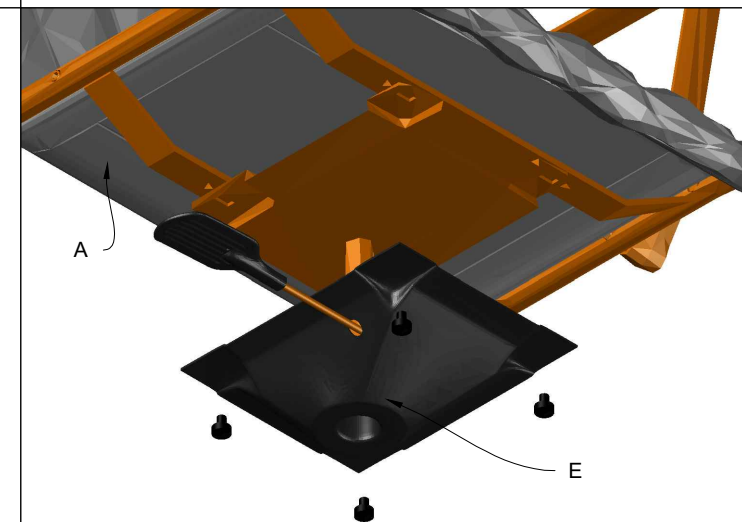

7) Posizionare il cono del movimento (E) nella colonna a gas (B) in modo da unire la scocca (A) e le parti assemblate precedentemente.

7) Position the cone of the movement (E) on the gas lift (B) to unite the body (A) to the beforehand assembled parts

